

视镜技术 Glass Technology



国家高新技术企业 浙江省著名商标
www.cndonjoy.com



东正一直致力于重大技术进步，是您值得信赖的事业伙伴！
Donjoy committing to major technological advances, is your reliable business partner!

0.1	自控调节阀+控制器 Automatic control regulating valve +Control head
0.2	生物制药隔膜阀 Biopharmaceutical diaphragm valve
0.3	高洁净泵 High purity pumps
0.4	防混蝶阀+蝶阀 Mixing proof butterfly valve +Butterfly valve
0.5	球阀 Ball valve
0.6	截止换向阀+防混阀+罐底阀 Divert seat valve+Mixing proof valve +Tank bottom valve
0.7	角座阀+截止阀 Angle seat valve+Globe valve
0.8	止回阀+恒压阀+安全阀+减压阀 Check valve+constant pressure valve+safety valve +air release valve
0.9	清洁技术+取样阀+视镜+照明技术 Clean technology+sample valve+sight glass +lighting technology
0.10	过滤器+人孔 Filter+man hole cover(manway)
0.11	卫生管件 Sanitary fittings ASME BPE DIN11852 B94825 SMS ISO IDF 3A



注意：
目录技术资料仅供设计参考，
设计更新和技术升级恕不另行通知！

不断革新的技术、日新月异的市场发展和客户需求是当今我们面临的巨大挑战。面对这些挑战我们信心十足，因为东正高度专业化的产品和技术创新，是我们未来将以更高、更优的产品来满足不断增长的市场需求。

Technological innovation, rapid development of the market and customer needs are the greatest challenges facing us today. Facing with these challenges we are confident, because of highly professional products and technological innovation, we will meet the growing demand of market and customer with our better and better products.

法律声明：
目录样册版本属东正所有，如有抄袭东正将追究其法律责任和经济赔偿。
东正众多技术设计，都具有专利保护，如有抄袭，东正必将追究法律责任和经济赔偿。

领先源于创新 创新源于专业

东正的专业与品质的邂逅源于创新的精神



现代化工厂已经投产，期待您的光临！
温州空港经济园区生产基地
Wenzhou airport economic zone production base

占地面积29000m²，总投资1.2亿元，新引进ABB工业机器人、日本马扎克5轴加工中心、ABB机器人抛光设备。

Covering an area of 29000 m², with total investment after construction is expected to 120 million yuan, introduces new ABB industrial robot, Japan mazar-e-sharif grams of five axis machining center, ABB machine Polishing equipment.

东正创立于1993年，注册资金5508万，是一家专注于研发高品质PID过程控制器、阀门定位器、流量控制器，阀门控制单元，高洁净过程控制阀、智能自控阀，高洁净泵、高洁净管材和管道配件。公司高度专业化的产品和技术专注于生物制药、食品饮料、酿酒、精细化工等工业领域。东正众多的创新解决方案，对满足全球，尤其是新兴市场不断增长生物制药和食品饮料行业的需求起到了积极作用。

东正制造的产品母材料、加工技术、焊接技术、表面处理等技术指标均已达到国内外先进水平。且符合ASME BPE、EHEDG、FDA、3A等一系列国际标准和规范要求，先后通过了由德国TÜV机构实施的欧盟承压设备指令(PED-97/23/EC)和(MD-06/42/EC)认证、美国3A机构实施的3-A卫生标准认证、中国安全阀特种制造设备(TS)许可证和中国质量认证中心CQC ISO9001:2008质量管理体系认证等多项国际权威认证。

东正凭借先进的技术、优异的品质和完善的售后服务体系，先后被评定为国家高新技术企业，省著名商标、省科技型企业、创新型企业、专利示范企业、研发中心企业，守合同重信用AAA企业等众多荣誉。

关于东正 About DONJOY

Donjoy was built up in 1993, with registered capital RMB 55,08 millions. We focus on developing high quality PID process controller, the valve positioner, the flow controller, the valve control unit, high purity process control valve, intelligent self-control valve, high purity pump, high purity tubing fitting and pipeline accessories. Donjoy's products and technologies are widely used in biopharmaceutical, food, drink, wine fine chemicals and other industrial fields. Donjoy's innovation solutions meet the growing demand of the industry of biopharmaceutical, food and beverage from the whole world, especially the emerging market.

Raw material, processing technology, welding technology, surface treatment from Donjoy have achieved advanced levels of domestic and foreign market. Donjoy productions according to ASME BPE, EHEDG, FDA and 3A standard, get certificate of PED-97/23/EC and MD-06/42/EC issued by TUV, 3A issued by 3A organization, TS licence and ISO9001:2008.

Donjoy with advanced technology, excellent quality and perfect after-sales service system, has been assessed as the national high-tech enterprises, the Provincial Famous Trademark, the Provincial Science and Technology Enterprises, Innovative Enterprises, Patent Model Enterprises, R & D Center, AAA Credit Enterprises.



创立于2005年现代化工厂
温州滨海经济开发区生产基地
Wenzhou binhai economic development zone production base

DONJOY high-purity valve, pump, control system, pipe and accessories, provide the most excellent solution for various business scopes.

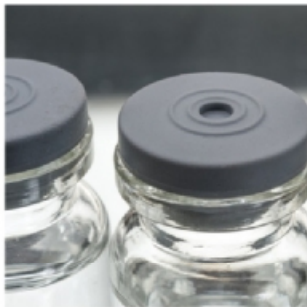

Biopharmaceutical



Dairy



Food



Beverage



Water Processing



Brewing



Fine Chemical

制造与检验 Manufacturing and testing



机器人生产线 Robot production line

全自动弯管设备 Automatic pipe bending equipment

DONJOY以科学技术是第一生产力，也是企业核心竞争力，只有不断投入核心技术研发和创新，不断追求卓越，精益求精、以先进生产设备，严格的质量管理体系，精密的生产检测流程，保证每一款产品优良的性能。

Science and technology constitute a primary productive force, also the core competitive strength of the enterprise. Continuously intensifying the research, development and innovation of core technology, pursuing prominence and keeping improving, ensuring the excellent quality and performance of every single product by advanced production equipment, strict quality control and precise production and inspection procedures.

荣誉与资质

Honor and qualification

	<p>3A</p> <p>东正是美国3A认证组织的金牌赞助商，3A是一个自愿组织，致力于维护公共卫生和奶制品产品质量通过独特的行业监管程序的设备，用于处理乳制品的卫生标准3A认证。 东正通过认证产品，阀门系列55-02-1783、64-00-1784、84-02-1786、85-03-1787、53-06-1782、54-02-1580、68-00-1785，管件(63-03)证书号(1581)等多种规格型号。</p>
	<p>PED/97/23/EC & MD/06/42EC</p> <p>东正通过了TUV 欧共体压力设备97/23/EC质量保证模式H&材料(管件)制造认证。 阀门证书 NO.CE 0036 泵类证书 NO.705201402401-00</p>
	<p>FDA177.2600</p> <p>东正生产的阀门和泵以及流体设备等，与物料接触密封圈全部通过或符合美国食品和药品管理局和联邦法规第21条即，CRF 21 FDA177.2600和FDA177.1550认证，其涵盖： EPDM VITON(FPM) SILICON HNBPTFE橡胶塑料材料等。</p>
	<p>ISO9001/2008</p> <p>东正通过中国质量认证中心CQC，ISO9001-2008/GB/T19001-2008企业质量管理体系认证。其证书编号: 00108Q24215R1M/3302</p>
	<p>卫生许可证</p> <p>东正通过了省卫生厅卫生阀门、卫生管件等检验，且获得了其颁发的证书，其编号: So083。 其许可证为国家出台的生活饮用水卫生监督管理方法证书。</p>
	<p>高新技术企业</p> <p>东正通过多年发展和技术创新已获得了多项国家发明专利，100多项实用新型专利，现已成为国家高新技术企业。</p>
	<p>浙江省著名商标</p> <p>东正09年获得了温州市著名商标，2012年获得了浙江省著名商标。</p>

DONJOY不但拥有以上认证和荣誉，且被评定为省科技型、创新型、专利示范、研发中心、守合同守信用企业等众多的荣誉证书。



充锂电池照明
有线供电DC24V照明
有线供电AC110V、220V照明
不锈钢外壳
防水、防爆
IP67防护

Charging lithium battery lighting
Wired power supply DC24V lighting
Wired power supply AC110V/220V lighting
Stainless steel housing
Waterproof, explosion
IP67 protection

直通视镜 Tubular sight glasses

应用 Applications

- ◆直通视镜由不锈钢结构和玻璃组成。在食品加工，化妆品，制药和精细化工工业中，可以通过它清晰并且精确的观察到物料流动。
- ◆A tubular sight-glass is comprised of stainless steel frame and glass. Through it, operator can observe the flowing of the liquid substance clearly and precisely in the fields of food, cosmetics, pharmaceutical and fine chemicals industries.

设计和特点 Design and features

- ◆规格：DN25/1"到DN100/4" ◆Size: DN25/1" to DN100/4"
- ◆全通径设计 ◆Full bore design
- ◆360度观看角度 ◆360° viewing angle
- ◆可以垂直或水平使用 ◆Can be used in vertical or horizontal position

材质 Materials

- ◆保护套：AISI 304 ◆Protective sleeve: AISI 304
- ◆玻璃：钢化玻璃 ◆Glass: tempered glass
- ◆垫圈：VMQ FDA 177.2600 ◆Gasket: VMQ FDA 177.2600
- ◆表面处理：CNC车床 ◆Surface treatment: CNC lathe

技术规格 Technical specifications

- ◆工作温度：-10℃到120℃ ◆ Working temp: -10°C to 120°C (Silicone)
- ◆最大操作压力(bar) ◆ Max. Operating pressure (bar) as following

DIN	25	32	40	50	65	80	100
PYREX玻璃glass	10	10	10	8	8	8	8

选项 Options

- ◆垫圈材质：NBR、EPDM、FPM所有都根据FDA177.2600
- ◆连接：焊接、卡箍、法兰、螺纹
- ◆标准：IDF, BS, RJT, SMS, DIN
- ◆Gasket material: NBR, EPDM, FPM in accordance with FAD177.2600
- ◆Connection: weld, clamp, flange, thread
- ◆Standard: IDF, BS, RJT, SMS, DIN

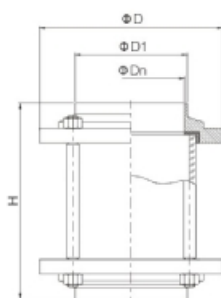

NO.VSJ100N1



不锈钢防护罩
Stainless steel protective cover

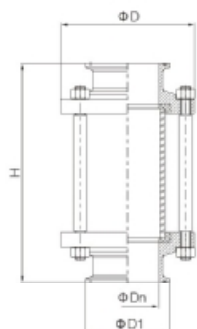

NO.VSJ110N1

INCH

SIZE	H	D	D1	Dn
1/2"	140	78	12.7	9.4
3/4"	140	78	19.1	15.8
1"	140	78	25.4	22.4
1 1/4"	140	78	31.8	28.8
1 1/2"	140	86	38.1	35.1
2"	142	102	50.8	47.8
2 1/2"	146	115	63.5	59.5
3"	146	124	76.2	72.2
3 1/2"	150	139	89	85
4"	156	154	101.6	97.6
5"	170	185	133	127
6"	180	215	147	153

DIN

SIZE	H	D	D1	Dn
DN10	140	78	13	10
DN15	140	78	18	15
DN20	140	78	22	19
DN25	140	78	28	25
DN32	140	86	34	31
DN40	140	90	40	37
DN50	142	102	52	49
DN65	146	124	70	66
DN80	150	139	85	81
DN100	156	154	104	100
DN125	170	185	129	125
DN150	180	215	154	150

INCH

SIZE	H	D	D1	Dn
1/2"	156	78	25.4	9.4
3/4"	156	78	25.4	15.8
1"	156	78	50.5	22.4
1 1/4"	156	78	50.5	28.8
1 1/2"	160	86	50.5	35.1
2"	166	102	64	47.8
2 1/2"	170	115	77.5	59.5
3"	174	124	91	72.2
3 1/2"	174	139	106	85
4"	196	154	119	97.6
5"	212	185	144.4	127
6"	236	215	183	153

DIN

SIZE	H	D	D1	Dn
DN10	156	78	34	10
DN15	156	78	34	15
DN20	156	78	34	19
DN25	156	78	50.5	25
DN32	156	78	50.5	31
DN40	160	86	50.5	37
DN50	166	102	64	49
DN65	174	120	91	66
DN80	174	134	106	81
DN100	196	154	119	100
DN125	212	185	144.4	125
DN150	236	215	167	150
DN200	256	285	217.4	200

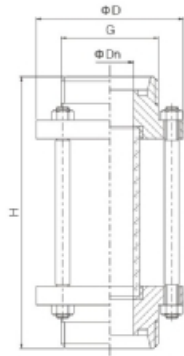

NO.DIN-VSJ130N1

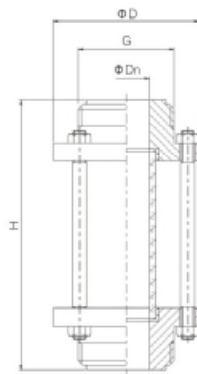

NO.IDF-VSJ130N1

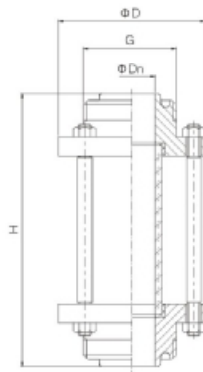

NO.RJT-VSJ130N1

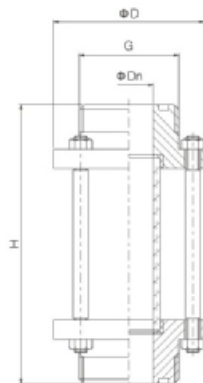

NO.SMS-VSJ130N1

DIN螺纹DIN thread

SIZE	H	G	D	Dn
DN10	156	RD28 × 1/8	78	10
DN15	156	RD33.5 × 1/8	78	15
DN20	156	RD43.5 × 1/6	78	19
DN25	156	RD51.5 × 1/6	78	25
DN32	160	RD57.5 × 1/6	86	31
DN40	164	RD64.5 × 1/6	90	37
DN50	166	RD77.5 × 1/6	106	49
DN65	170	RD94.5 × 1/6	124	66
DN80	174	RD109.2 × 1/4	139	81
DN100	196	RD129.2 × 1/4	159	100
DN125	220	RD159.2 × 1/4	185	125
DN150	240	RD189.2 × 1/4	215	150

ISO/IDF螺纹ISO/IDF thread

SIZE	H	G	D	Dn
1"	162	37.1 × 1/8Acme	78	22.4
1 1/2"	166	50.6 × 1/8Acme	86	35.1
2"	172	64.1 × 1/8Acme	102	47.8
2 1/2"	176	77.6 × 1/8Acme	115	60.5
3"	180	91.1 × 1/8Acme	128	72.2
4"(ISO)	202	118.2 × 1/8Acme	154	97.6
4"(IDF)	202	125.9 × 1/6Acme	154	97.6

RJT螺纹RJT thread

SIZE	H	G	D	Dn
1"	170	45.7 × 1/8TWHIT	78	22.2
1 1/2"	170	58.4 × 1/8TWHIT	86	34.9
2"	174	72.7 × 1/6TWHIT	102	47.6
2 1/2"	174	85.4 × 1/6TWHIT	115	60.3
3"	174	98.1 × 1/6TWHIT	128	73.0
4"	196	123.8 × 1/6TWHIT	154	97.5

SMS螺纹SMS thread

SIZE	H	G	D	Dn
3/4"	156	RD35.5 × 1/8	78	16
1"	156	RD39.5 × 1/6	78	22.4
1 1/4"	156	RD47.5 × 1/6	78	28.8
1 1/2"	160	RD59.5 × 1/6	86	35.1
2"	166	RD69.5 × 1/6	102	47.8
2 1/2"	170	RD84.5 × 1/6	115	59.5
3"	174	RD97.2 × 1/6	128	72.2
3 1/2"	176	RD104.2 × 1/6	139	85
4"(小)	196	RD124.2 × 1/4	154	97.6
4"(大)	196	RD131.2 × 1/4	159	97.6

新一代无菌、无死角视镜 Aseptic and no Zero-dead Angle sight glass(New type)



NEW



应用 Applications

- ◆直通视镜由不锈钢结构和玻璃组成。在食品加工，化妆品，制药和精细化工工业中，可以通过它清晰并且精确的观察到物料的流程。
- ◆A tubular sight-glass is comprised of stainless steel frame and glass. Through it, operator can observe the flowing of the liquid substance clearly and precisely in the fields of food, cosmetics, pharmaceutical and fine chemicals industries.

技术规格 Technical specifications

- ◆工作温度: -10°C到120°C
- ◆最大操作压力(bar)
- ◆ Working temp: -10°C to 120°C
- ◆ Max. Operating pressure (bar) as following

DIN	25	32	40	50	65	80	100
PYREX玻璃glass	10	10	10	8	8	8	8

设计和特点 Design and features

- ◆规格: DN25/1"到DN100/4"
- ◆全通径设计
- ◆360° 观察
- ◆可任意角度安装
- ◆Size: DN25/1" to DN100/4"
- ◆Full bore design
- ◆360° observation
- ◆Can be installed at any angle

材质 Materials

- ◆保护套: AISI 304
- ◆玻璃: 钢化玻璃
- ◆垫圈: EPDM FDA 177.2600
- ◆液体接触: ASME 316L/304
- ◆Protective sleeve: AISI 304
- ◆Glass: tempered glass
- ◆Gasket: EPDM FDA 177.2600

视窗玻璃
Sight glass

防护套
Protect sleeve



NEW



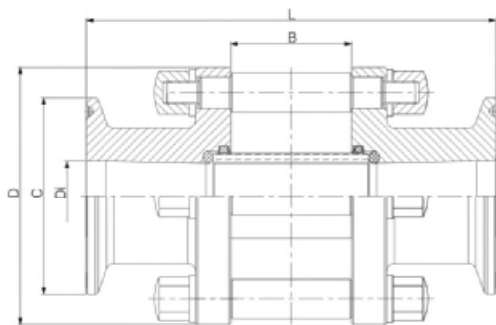

NO.VSJ610N1

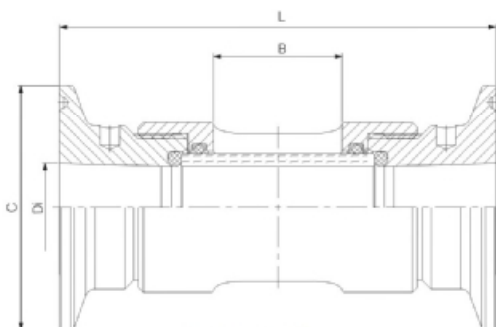

NO.VSJ610N2

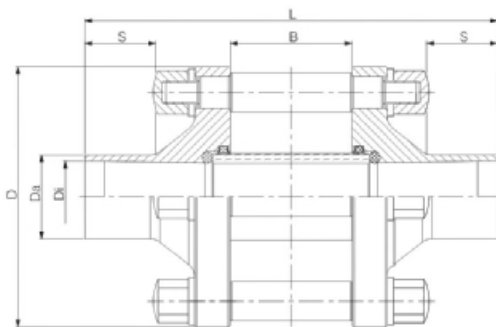

NO.VSJ600N1

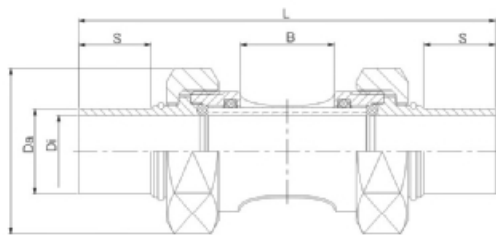

NO.VSJ600N3

Orifice	D (mm)	C (mm)	Di (mm)	B (mm)	L (mm)
BS-OD Dimensions Inline flow indicator with Clamp connection / full view version					
DN1"	73.00	50.50	22.10	36.00	105.00
DN1 1/2"	82.00	50.50	34.80	37.00	105.00
DN2"	100.00	64.00	47.50	54.00	140.00
DN2 1/2"	124.00	77.50	60.20	67.00	151.00
DN3"	135.00	91.00	72.90	97.00	181.00
DN4"	159.00	119.00	97.38	119.00	206.00

Orifice	D (mm)	C (mm)	Di (mm)	B (mm)	L (mm)
DIN Dimensions Inline flow indicator with Clamp connection / full view version					
DN25	80.00	50.50	26.00	32.00	105.00
DN32	80.00	50.50	32.00	32.00	105.00
DN40	90.00	50.50	38.00	41.20	121.00
DN50	100.00	64.00	50.00	67.00	140.00
DN65	130.00	91.00	66.00	67.00	158.00
DN80	145.00	106.00	81.00	110.00	196.00
DN100	160.00	119.00	100.00	97.00	184.00

Orifice	C (mm)	Di (mm)	B (mm)	L (mm)
DIN Dimensions Inline flow indicator with Clamp connection / standard				
ASME DN1/4"	25.00	4.6	20.00	76.00
ASME DN3/8"	25.00	7.75	20.00	76.00
ASME DN1/2"	25.00	9.40	20.00	76.00
ASME DN3/4"	25.00	15.75	30.00	92.00
ASME DN1"	50.50	22.10	30.00	92.00
ASME DN1 1/2"	50.50	34.80	32.00	115.00
ASME DN2"	64.00	47.50	48.00	120.00

Orifice	C (mm)	Di (mm)	B (mm)	L (mm)
DIN Dimensions Inline flow indicator with Clamp connection / standard				
DN08	25.00	8.00	20.00	76.00
DN10	34.00	10.00	20.00	76.00
DN15	50.50	16.00	30.00	92.00
DN20	50.50	20.00	30.00	92.00
DN25	50.50	26.00	32.00	92.00
DN32	50.50	32.00	32.00	92.00
DN40	64.00	38.00	32.00	120.00
DN50	64.00	50.00	48.00	120.00

Orifice	D (mm)	Da (mm)	Di (mm)	L (mm)	S (mm)	B (mm)
BS-OD Dimensions Inline flow indicator with weld end / full view version						
ASME DN1"	73.00	25.40	22.10	149.00	38.10	36.00
ASME DN1 1/2"	82.00	38.10	34.80	152.00	38.10	36.00
ASME DN2"	100.00	50.80	47.50	190.00	38.10	54.00
ASME DN2 1/2"	124.00	63.50	60.20	222.00	38.10	67.00
ASME DN3"	135.00	76.20	72.90	241.00	38.10	97.00
ASME DN4"	159.00	101.60	97.40	263.00	38.10	119.00

Orifice	D (mm)	Da (mm)	Di (mm)	L (mm)	S (mm)	B (mm)
DIN Dimensions Inline flow indicator with weld end / full view version						
DN25	73.00	29.00	26.00	115.00	18.00	36.00
DN32	82.00	35.00	32.00	115.00	18.00	36.00
DN40	82.00	41.00	38.00	125.00	20.00	41.20
DN50	100.00	53.00	50.00	156.00	20.00	65.00
DN65	124.00	70.00	66.00	158.00	20.00	67.00
DN80	145.00	85.00	81.00	207.00	20.00	97.00
DN100	160.00	104.00	100.00	214.00	25.00	118.40

Orifice	D (mm)	Da (mm)	Di (mm)	L (mm)	S (mm)	B (mm)
BS-OD Dimensions Inline flow indicator with weld end / standard						
ASME DN1/4"	21.94	6.35	4.60	92.00	18.00	20.20
ASME DN3/8"	25.40	9.50	7.70	107.30	25.10	21.00
ASME DN1/2"	31.18	12.70	9.40	107.00	25.40	18.00
ASME DN3/4"	36.95	19.05	15.75	120.00	25.10	20.00
ASME DN1"	48.30	24.40	22.10	121.00	25.40	30.00
ASME DN1 1/2"	62.00	38.10	34.80	136.00	25.40	32.00
ASME DN2"	80.00	50.80	47.50	161.50	25.40	48.00

Orifice	D (mm)	Da (mm)	Di (mm)	L (mm)	S (mm)	B (mm)
DIN Dimensions Inline flow indicator with weld end / standard						
DIN DN08	25.40	10.00	8.00	92.50	18.00	17.00
DIN DN10	31.18	12.00	10.00	92.00	18.00	18.00
DIN DN10	31.18	13.00	10.00	92.50	18.00	18.00
DIN DN15	36.95	19.00	16.00	110.00	18.00	20.00
DIN DN20	48.30	23.00	20.00	110.00	18.00	28.00
DIN DN25	48.00	29.00	26.00	110.00	18.00	24.00
DIN DN32	62.00	35.00	32.00	114.50	18.00	24.00
DIN DN40	62.00	41.00	38.00	122.50	18.00	31.00
DIN DN50	80.00	53.00	50.00	154.50	18.00	54.00



新一代四通视镜、零死角、零滞留

Four-way sight glass, zero dead angle, no retention

充电式灯视镜
Rechargeable battery



基本型
Standard type



接线供电灯视镜
Connection cable



不锈钢外壳, DC24V供电
Stainless steel Shell, DC 24V

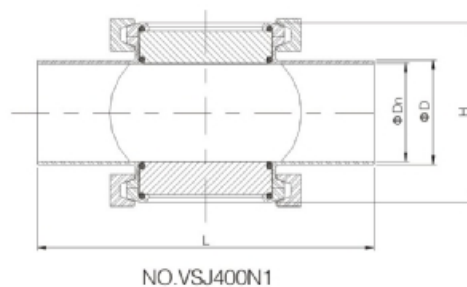
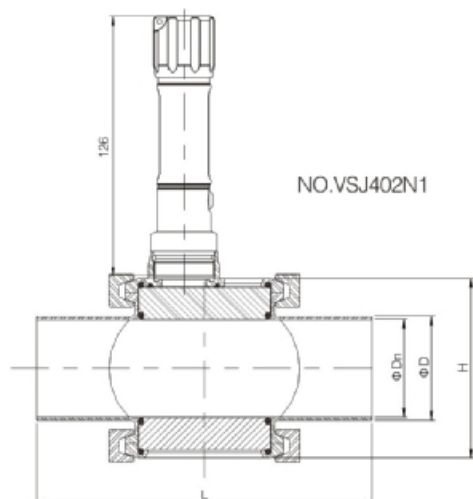

应用 Applications

- ◆四通视镜由不锈钢结构和钢化玻璃组成。在食品加工，化妆品，制药和精细化工工业中，可以通过它清晰并且精确的观察到物料的流程。
- ◆Four-way sight glass is comprised of stainless steel frame and tempered glass. Through it, operator can observe the flowing of the liquid substance clearly and precisely in the fields of food, cosmetics, pharmaceutical and fine chemicals industries.

设计和特点 Design and features

- ◆规格从1"-4"到DN25-DN100玻璃通过卡箍安装到机构上
- ◆连接: 螺纹、卡箍、焊接、DIN、SMS、IDF
- ◆垫圈材质: EPDM NBR 符合FDA177.2600
- ◆材质: AISI 304(1.4301) AISI 316L(1.4404)
- ◆基本型最高温度: -10°C-150°C
- ◆基本型+视镜灯: -10°C-80°C(取决于灯耐温)
- ◆Size: 1"-4" to DN25-DN100 the glass can be installed on the quipment through clamps.
- ◆Connection: weld, clamp, thread, DIN, SMS, IDF
- ◆Gasket material: NBR, EPDM, FPM in accordance with FAD177.2600
- ◆Material: AISI304(1.4301) AISI316L(1.4404)
- ◆Max temperature(Basic): -10°C-150°C
- ◆Max temperature (Basic with clamp): -10°C-80°C (dependigon light heat resistance)

技术优势 Technical advantage

- ◆无滞留、零死角、强光、白色冷光源、防水、防爆设计
- ◆有线供电AC110V/220V、DC24V
- ◆无线供电，一次充电可使用2-3月(根据频率而定)
- ◆No retention, zero dead angle, high light, white cold light source, waterproof, explosion-proof .
- ◆Cable power supply AC110V/220V, DC24V
- ◆Wireless power supply, one charging can be used 2-3 months (Depending on the frequency)

DIN四通视镜 DIN four-way glass

SIZE	D	Dn	H	L
DN40	40	37	75.1	165
DN50	52	49	87.8	165
DN65	70	66	108	218
DN80	85	81	123	250
DN100	104	100	141.6	300

INCH四通视镜 INCH four-way glass

SIZE	D	Dn	H	L
1 1/2"	38.1	35.1	75.1	165
2"	50.8	47.8	87.8	165
2 1/2"	63.5	59.5	101.5	205
3"	76.2	72.2	114.2	230
4"	101.6	97.6	141.6	300

法兰视镜 Flanged sight glass

不锈钢外壳, DC24V供电
Stainless steel shell, DC24V power supply



充电/有线供电, 灯法兰视镜
Charging/cable power supply, flange sight glass with lamp



技术优势 Technical advantage

- ◆强光、白色冷光源/防水、防爆设计
- ◆有线供电AC110V-220V、DC24V
- ◆无线供电, 一次充电可以使用2-3个月(根据频率而定)

- ◆High light, white cold light source/waterproof, explosion-proof design.
- ◆Cable power supply AC110V-220V, DC24V
- ◆Wireless power supply, one charging can use 2-3 months (Depending on the frequency)

应用 Applications

- ◆法兰视镜由不锈钢结构和钢化玻璃组成。在食品加工, 化妆品, 制药和精细化工工业中, 可以通过它清晰并且精确的观察到物料流动。
- ◆Flanged sight glass is comprised of stainless steel frame and glass. Through it, operator can observe the flowing of the liquid substance clearly and precisely in the fields of food, cosmetics, pharmaceutical and fine chemicals industries.

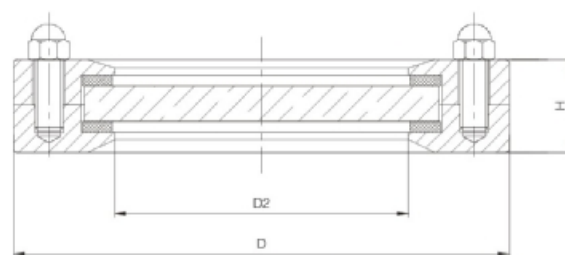

NO.VSJ200N1

设计和特点 Design and features

- ◆规格从1.5"-8"到DN40-DN200
- ◆通过内六角螺栓将两片法兰及玻璃装配在一起
- ◆垫圈材质: PTFE 符合FDA177.1600
- ◆材质: AISI 304(1.4301) AISI 316L(1.4404)
- ◆最大温度: -10°C到+120°C
- ◆最大压力: 10bar
- ◆Size: 1.5"-8" to DN40-DN200
- ◆Assemble flange with glass by using hexagon socket bolts
- ◆Gasket material: PTFE in accordance with FAD 177.1600
- ◆Material: AISI304(1.4301) AISI316L(1.4404)
- ◆Max. Temperature: -10°C to +120°C
- ◆Max. Pressure: 10bar

法兰视镜 Flange dsight glass

SIZE	H	D	D2
DN40	25	115	68
DN50	29	140	78
DN65	29	155	98
DN80	29	155	98
DN100	30	190	128
DN125	33	224	154
DN150	41	250	183
DN200	45	310	233

由任视镜

Union-type-sight-galss



卡箍由任式视镜
Clamp union-type-sight-glass

应用 Applications

- ◆带有透明的圆形玻璃，螺纹管口处有焊颈。
- ◆观看口用于观看生物反应器，实验室搅拌机、过滤器、处理容器、管道和其他关闭的容器。尤其适合于制药，食品和饮料加工，比如要酿酒厂、牛奶厂。
- ◆Union-type-sight-glass DIN11851/SMS (standard for dairy products), with transparent circular glass. Threaded nozzle with the welded neck.
- ◆It is used viewing the biologic reactor, blender in laboratory, fitter, processing container, pipeline and other closed container. Especially apply in pharmacy, food and beverage processing, such as the brewery, dairy.

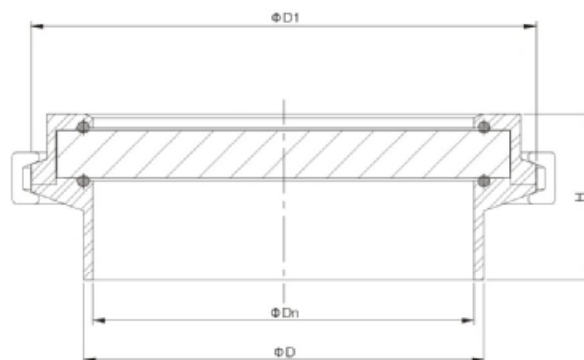

NO.VSJ500N1

材质 Materials

- ◆密封圈：EPDM FPM
- ◆与物料接触部位：1.4301(304)；1.4404(316L)
- ◆Seal: VEPDM FPM
- ◆The parts contact with liquid: 1.4301(304)；1.4404(316L)

操作条件 Operational term

- ◆压力：真空-10bar
- ◆温度：-10°C / 130°C
- ◆Pressure: Vacuum -10bar
- ◆Temperature: Max.-10°C / 130°C

DIN卡箍由任视镜 DIN Clamp union sight glass

SIZE	D	Dn	D1	H
DN40	40	37	50.5	35.5
DN50	52	49	64	35.5
DN65	70	66	91	35.5
DN80	85	81	106	35.5
DN100	104	100	130	37.5

INCH卡箍由任视镜 INCH Clamp union sight glass

SIZE	D	Dn	D1	H
1.5"	38.1	35.1	50.5	35.5
2"	50.8	47.8	64	35.5
2.5"	63.5	59.5	77.5	35.5
3"	76.2	72.2	91	35.5
4"	101.6	97.6	130	37.5

由任视镜

Union-type-sight-galss



应用 Applications

- ◆带有透明的圆形玻璃，螺纹管口处有焊颈。
- ◆观看口用于观看生物反应器，实验室搅拌器、过滤器、处理容器、管道和其他关闭的容器。尤其适合于制药，食品和饮料加工，比如要酿酒厂、牛奶厂。
- ◆Union-type-sight-glass DIN11851/SMS (standard for dairy products), with transparent circular glass. Threaded nozzle with the welded neck.
- ◆It is used viewing the biologic reactor, blender in laboratory, fitter, processing container, pipeline and other closed container. Especially apply in pharmacy, food and beverage processing, such as the brewery, dairy.

材质 Materials

- ◆密封圈: EPDM FPM
- ◆与物料接触部位: 1.4301(304); 1.4404(316L)
- ◆Seal: VEPDM FPM
- ◆The parts contact with liquid: 1.4301(304); 1.4404(316L)

操作条件 Operational term

- ◆压力: 真空-10bar
- ◆温度: -10℃ / 130℃
- ◆Pressure: Vacuum -10bar
- ◆Temperature: Max. -10℃ / 130℃

卡箍由任式视镜
Clamp union-type-sight-glass

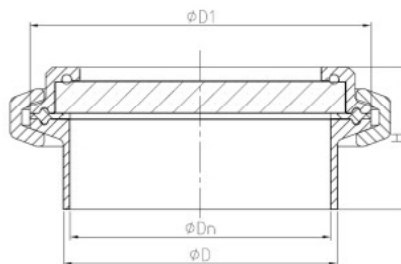

NO. VSJ500N1

DIN卡箍由任视镜

DIN Clamp union sight glass

SIZE	D	Dn	D1	H
DN40	40	37	50.5	36.5
DN50	52	49	64	36.5
DN65	70	66	91	37.5
DN80	85	81	106	44
DN100	104	100	130	46
DN125	129	125	145	46
DN150	154	150	183	49
DN200	204	200	233.5	58.5

INCH卡箍由任视镜

INCH Clamp union sight glass

SIZE	D	Dn	D1	H
1.5"	38.1	35.1	50.5	36.5
2"	50.8	47.8	64	36.5
2.5"	63.5	59.5	77.5	37.5
3"	76.2	72.2	91	37.5
4"	101.6	97.6	130	39.5
6"	152.4	146.8	167	42.5
8"	203.2	197.6	217	52
10"	254	247.2	268	52

法兰视镜 Flanged sight glass

不锈钢外壳, DC24V供电
Stainless steel shell, DC24V power supply



技术优势 Technical advantage

- LED视镜灯有两种设计:
1) 铝合金外壳:
• 强光, 白色冷光源/防水, 防爆设计
• 有线供电 AC110V-220V, DC24V
• 无线供电, 一次充电可以使用2-3个月(根据频率而定)
2) 不锈钢外壳:
• 强光, 白色冷光源, 防水, 防爆设计
• 有线供电: DC 24V±10%

应用 Applications

- 法兰视镜由不锈钢结构和钢化玻璃组成。在食品加工, 化妆品, 制药和精细化工工业中, 可以通过它清晰并且精确的观察物料的流动。
- Flanged sight glass is comprised of stainless steel frame and glass. Through it, operator can observe the flowing of the liquid substance clearly and precisely in the fields of food, cosmetics,

- LED lights have two designs:
1) Aluminum alloy shell:
• High light, white cold light source/waterproof, explosion-proof design.
• Cable power supply AC110V-220V, DC24V
• Wireless power supply, one charging can use 2-3 months (Depending on the frequency)
2) stainless steel shell
• High light, white cold light source/waterproof, explosion-proof

设计和特点 Design and features

- 规格从1.5"-12"到DN40-DN300
- 通过内六角螺栓将两片法兰及玻璃装配在一起
- 垫圈材质: PTFE 符合FDA177.1600
- 材质: AISI 304(1.4301) AISI 316L(1.4404)
- 最大温度: -10°C到+120°C
- 最大压力: 10bar
- Size: 1.5"-12" to DN40-DN300
- Assemble flange with glass by using hexagon socket bolts
- Gasket material: PTFE in accordance with FAD 177.1600
- Material: AISI304(1.4301) AISI316L(1.4404)
- Max. Temperature: -10°C to +120°C
- Max. Pressure: 10bar

法兰视镜 Flange dsight glass

SIZE	H	Ø	LD
DN40	25	115	68
DN50	29	140	78
DN65	29	150	98
DN80	29	155	98
DN100	30	190	128
DN125	30	204	164
DN150	31	250	195
DN200	45	310	235



法兰视镜 Flanged sight glass

不锈钢外壳, DC24V供电
Stainless steel shell, DC24V power supply



技术优势 Technical advantage

- LED视镜灯有两种设计:
 - 1) 铝合金外壳:
 - 强光、白色冷光源/防水、防爆设计
 - 有线供电AC110V-220V、DC24V
 - 无线供电, 一次充电可以使用2-3个月(根据频率而定)
 - 2) 不锈钢外壳:
 - 强光、白色冷光源、防水、防爆设计
 - 有线供电: DC 24V±10%

- LED lights have two designs:
 - 1) Aluminum alloy shell:
 - High light, white cold light source/waterproof, explosion-proof design.
 - Cable power supply AC110V-220V, DC24V
 - Wireless power supply, one charging can use 2-3 months (Depending on the frequency)
 - 2) stainless steel shell
 - High light, white cold light source/waterproof, explosion-proof

应用 Applications

- 法兰视镜由不锈钢结构和钢化玻璃组成。在食品加工, 化妆品, 制药和精细化工工业中, 可以通过它清晰并且精确的观察到物料流动。
- Flanged sight glass is comprised of stainless steel frame and glass. Through it, operator can observe the flowing of the liquid substance clearly and precisely in the fields of food, cosmetics,

设计和特点 Design and features

- 规格从1.5"-12"到DN40-DN300
- 通过内六角螺栓将两片法兰及玻璃装配在一起
- 垫圈材质: PTFE 符合FDA177.1600
- 材质: AISI 304(1.4301) AISI 316L(1.4404)
- 最大温度: -10°C到+120°C
- 最大压力: 10bar
- Size: 1.5"-12" to DN40-DN300
- Assemble flange with glass by using hexagon socket bolts
- Gasket material: PTFE in accordance with FAD 177.1600
- Material: AISI304(1.4301) AISI316L(1.4404)
- Max. Temperature: -10°C to +120°C
- Max. Pressure: 10bar

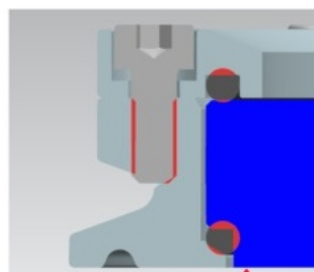

无死角的设计
玻璃和接头完全齐平

法兰视镜 Flange sight glass

SIZE	D
DN65/3"	91
DN80/3.5"	106
DN100/4"	119
DN125/5"	145
DN150/6"	167
DN200/8"	217.7

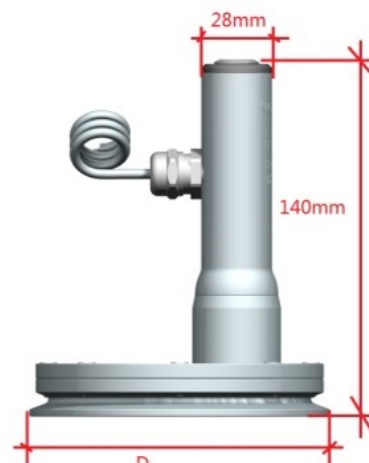

由任视镜+照明 Union-type-sight-galss+ lighting

技术特点 Technical features

- ◆压力：真空-10bar
- ◆温度：-10°C至150°C，由任+照明-10°C至80°C
- ◆材质：304(1.4301) 316L(1.4404)

- ◆Pressure: Vacuum 10bar
- ◆Temperature: -10°C to 150°C, Union+lighting-10°C to 80°C
- ◆Materials: 304(1.4301) 316L(1.4404)



由任视镜+照明+刮尘
Union sight glass + lighting + scraper

- ◆DN80-DN150, 4"-6"
- ◆一次充电使用2-3个月
(根据使用频率而定)
- ◆AC220V/110V
- ◆防水、防爆、卫生设计
- ◆DN80-DN150, 4"-6"
- ◆One charge can be used for 2-3 months
(depending on frequency of use)
- ◆AC220V/110V
- ◆Waterproof, explosion-proof,
hygienic design



由任视镜+照明
Union sight glass+ Lighting

- ◆DN65-DN150, 3"-6"
- ◆一次充电使用2-3个月
(根据使用频率而定)
- ◆AC220V/110V
- ◆防水、防爆、卫生设计
- ◆DN65-DN150, 3"-6"
- ◆One charge can be used for 2-3 months
(depending on frequency of use)
- ◆AC220V/110V
- ◆Waterproof, explosion-proof,
hygienic design



由任视镜+照明+刮尘
Union sight glass + Stainless
steel lighting +The wiper

- ◆DN80-DN150, 4"-6"
- ◆供电DC24V
- ◆防水、卫生设计
- ◆预制电缆2M
- ◆预制针孔插头
- ◆DN80-DN150, 4"-6"
- ◆Powered DC24V
- ◆Waterproof hygienic design
- ◆Precast cable 2M
- ◆Precast pinhole plugs



由任视镜+不锈钢照明
union sight glass + stainless
steel lighting

- ◆DN65-DN150, 3"-6"
- ◆供电DC24V
- ◆防水、卫生设计
- ◆预制电缆2M
- ◆预制针孔插头
- ◆DN65-DN150, 3"-6"
- ◆Powered DC24V
- ◆Waterproof hygienic design
- ◆Precast cable 2M
- ◆Precast pinhole plugs



由任视镜+无电缆照明+刮尘
Union sight glass illumination +
without cable lighting+The wiper

- ◆DN80-DN150, 4"-6"
- ◆5号干电池A/A/1.5V
- ◆DN80-DN150, 4"-6"
- ◆No.5 battery A / A / 1.5V



由任视镜+无电缆照明
union sight glass + without
cable lighting

- ◆DN65-DN150, 3"-6"
- ◆5号干电池A/A/1.5V
- ◆DN65-DN150, 3"-6"
- ◆No.5 battery A / A / 1.5V

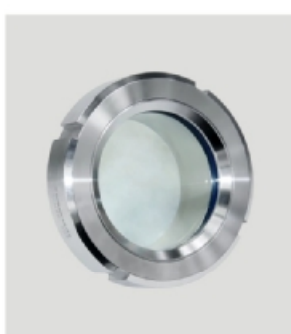

基本由任视镜
Basic union sight glass

- ◆DN25-DN150, 1"-6"
- ◆材质：304/316L
- ◆DN25-DN150, 1"-6"
- ◆Material: 304 / 316L

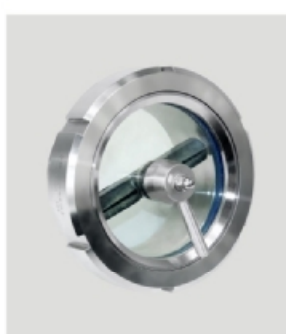

由任视镜+刮尘
Sight glass + The wiper

- ◆DN50-DN150, 2"-6"

由任视镜 Union-type-sight-galss

由任视镜+充电照明
sight glass Rechargeable Lighting

供电: AC220V/110V
一次充电可使用2-3个月
(使用频率而定)

Powered: AC220V/110V
On a single charge be used for
2-3 months (depending on
frequency of use)

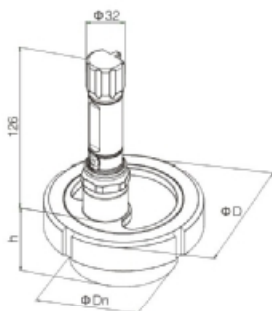

NO.VSJ302N1

由任视镜+不锈钢照明
sight glass + stainless steel lighting

DC24V
预制电缆2M
预制针孔插头 (选项)

DC24V
Precast cable 2M
Precast pinhole plugs (option)

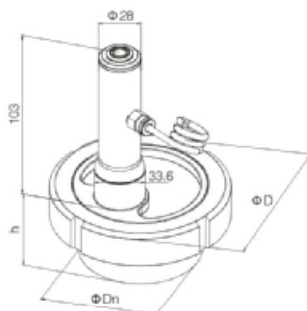

NO.VSJ303N1
由任视镜+照明

由任视镜+不锈钢照明
sight glass + stainless steel lighting

5号干电池
5 battery

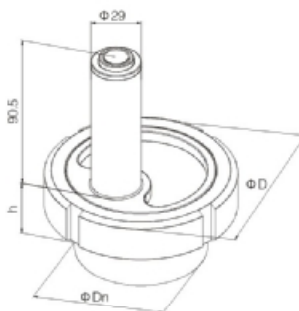

NO.VSJ301N1
由任视镜+照明

DIN

SIZE	D	Dn	h
DN50*	92	55	38
DN65	110	72	44
DN80	125	87	49
DN100	146	106	57
DN125	178	132	52
DN150	210	157	53

INCH

SIZE	D	Dn	h
2"	92	50.8	30
2.5"	110	63.5	30
3"	125	76.2	33
4"	146	101.6	34
-	-	-	-
6"	210	152.4	53

注意: 带 "*" 只适用于由任视镜+不锈钢外壳照明, 使5号干电池
Note: Above size with "*" only suitable for union-type sight glass with SS lighting(NO.5 battery)

由任视镜+充电照明+刮尘
sight glass Rechargeable
Lighting+The wiper

供电: AC220V/110V
一次充电可使用2-3个月
(使用频率而定)

Powered: AC220V/110V
On a single charge be
used for 2-3 months
(depending on frequency
of use)



NO.VSJ301Y1

由任视镜+不锈钢照明+刮尘
sight glass + stainless steel
lighting+The wiper

DC24V
预制电缆2M
预制针孔插头 (选项)

DC24V
Precast cable 2M
Precast pinhole plugs (option)

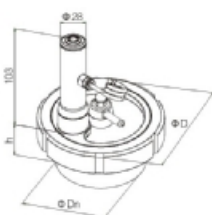

NO.VSJ303Y1

由任视镜+不锈钢照明+刮尘
sight glass + stainless steel
lighting+The wiper

5号干电池
5 battery

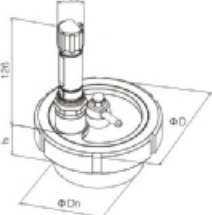

NO.VSJ302Y1

由任视镜+刮尘
sight glass + The wiper

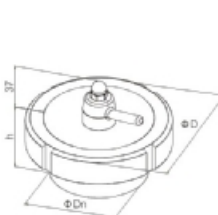

NO.VSJ300Y1

DIN

SIZE	D	Dn	h
DN50*	92	55	45
DN65*	110	72	48
DN80	125	87	53
DN100	146	106	63
DN125	178	132	57
DN150	210	157	62

INCH

SIZE	D	Dn	h
2"	92	50.8	33
2.5"	110	63.5	37
3"	125	76.2	37
4"	146	101.6	40
-	-	-	-
6"	210	152.4	62

注意: 带 "*" 只适用于由任视镜+刮尘
Note: Above size with "*" only
suitable for union-type sight glass with wi per

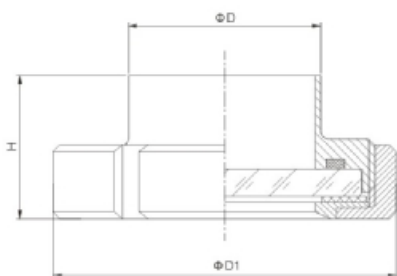

NO.VSJ300N1

DIN

SIZE	D	D1	H
DN25	28	63	26.5
DN32	34	70	26
DN40	40	78	26
DN50	52	92	28
DN65	70	110	29
DN80	85	125	32
DN100	104	146	36
DN125	129	178	40
DN150	154	210	46

INCH

SIZE	D	D1	H
1"	25.4	50	24.5
1 1/4"	31.8	60	26
1 1/2"	38.1	72	28
2"	50.8	82	28
2 1/2"	63.5	97	32
3"	76.2	111	32
3 1/2"	89.0	118	33
4"	101.6	138	36
6"	152.4	210	45

多角度视镜灯/工业照明/防水/防爆/卫生设计

Multi-angle sight glass/industrial lighting/water proof/explosion-proof /hygenic design

技术特点 Technical features

- ◆304外壳、强光、白色冷光源、防水、防爆设计
- ◆DC 24V
- ◆预制电缆2M, 预制插头 2 针
- ◆开关指示灯

- ◆304 shell, high light white cold light source/waterproof, explosion-proof design.
- ◆DC 24V
- ◆Precast cable 2M, precast plugs 2 core pinhole
- ◆Switch indicator



多角度照明视镜灯 Multi-angle Lighting

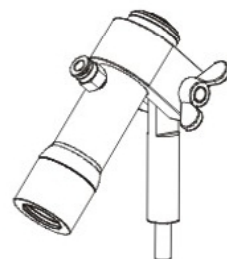
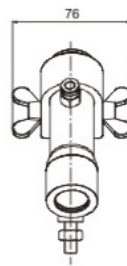
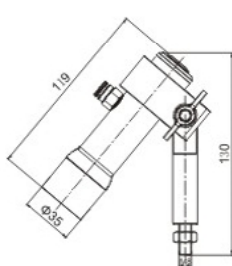

NO. EZM320

技术特点 Technical features

- ◆强光、白色冷光源、防水、防爆设计
- ◆有线AC 220V/110V
- ◆无线供电, 一次充锂电池可使用2-3个月(根据使用频率而定)

- ◆High light, white cold light source/waterproof, explosion-proof design.
- ◆Cable power supply AC110V-220V, DC24V
- ◆Wireless power supply, one charging can use 2-3 months (Depending on the frequency)



多角度照明视镜灯 Multi-angle Lighting

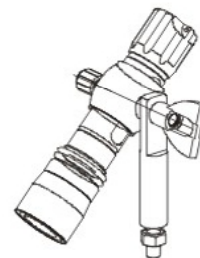
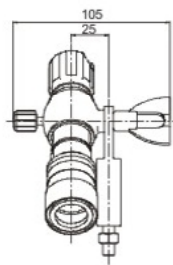
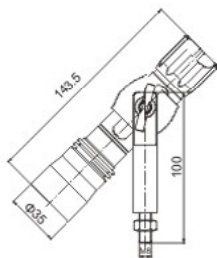

NO. EZM220



卡箍视镜灯
Clamp Lighting

焊接灯视镜
Welding Lighting

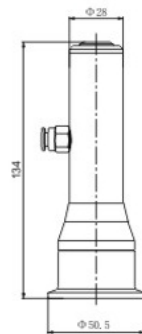

NO. EZM311

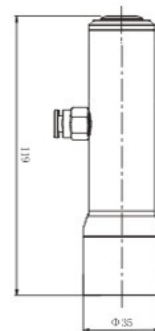

NO. EZM310



CHINA DONJOY TECHNOLOGY CO.,LTD.

DONJOY looking forward to your visit! Your telecommunications!



中国·东正
科技有限公司

地址: 温州龙湾区空港新区港富路25号
总机: 0577-86990888
传真: 0577-86998000

Add : No.25 Gang fu Road,
kong gang new District,
Longwan Wenzhou,China
Tel: +86-577-86990888
Fax: +86-577-86998000
E-mail: donjoy@cndonjoy.com

www.cndonjoy.com

法律声明:

目录样册版本属东正所有, 如有抄袭东正将追究其法律责任和经济赔偿。
东正众多技术设计, 都具有专利保护, 如有抄袭, 东正必将追究法律责任和经济赔偿。