

# 过滤器系列 Filter series

0.10



国家高新技术企业 浙江省著名商标  
[www.cndonjoy.com](http://www.cndonjoy.com)

 **DONJOY** 东正

东正一直致力于重大技术进步，是您值得信赖的事业伙伴！  
Donjoy committing to major technological advances, is your reliable business partner!

0.1	自控调节阀+控制器 Automatic control regulating valve +Control head
0.2	生物制药隔膜阀 Biopharmaceutical diaphragm valve
0.3	高洁净泵 High purity pumps
0.4	防混蝶阀+蝶阀 Mixing proof butterfly valve +Butterfly valve
0.5	球阀 Ball valve
0.6	截止换向阀+防混阀+罐底阀 Divert seat valve+Mixing proof valve +Tank bottom valve
0.7	角座阀+截止阀 Angle seat valve+Globe valve
0.8	止回阀+恒压阀+安全阀+减压阀 Check valve+constant pressure valve+safety valve +air release valve
0.9	清洁技术+取样阀+视镜+照明技术 Clean technology+sample valve+sight glass +lighting technology
0.10	过滤器+人孔 Filter+man hole cover(manway)
0.11	卫生管件 Sanitary fittings ASME BPE DIN11852 B&4825 SMS ISO IDF 3A



注意：  
目录技术资料仅供设计参考，  
设计更新和技术升级恕不另行通知！

不断革新的技术、日新月异的市场发展和客户需求是当今我们面临的巨大挑战。面对这些挑战我们信心十足，因为东正高度专业化的产品和技术创新，是我们未来将以更高、更优的产品来满足不断增长的市场需求。

Technological innovation, rapid development of the market and customer needs are the greatest challenges facing us today. Facing with these challenges we are confident, because of highly professional products and technological innovation, we will meet the growing demand of market and customer with our better and better products.

法律声明：  
目录样册版本属东正所有，如有抄袭东正将追究其法律责任和经济赔偿。  
东正众多技术设计，都具有专利保护，如有抄袭，东正必将追究法律责任和经济赔偿。

领先源于创新 创新源于专业  
东正的专业与品质的邂逅源于创新的精神



现代化工厂已经投产，期待您的光临！  
温州空港经济园区生产基地  
Wenzhou airport economic zone production base

占地面积29000m<sup>2</sup>，总投资1.2亿元，新引进工业机器人、5轴加工中心、机器人抛光设备。

Covering an area of 29000 m<sup>2</sup>, with total investment after construction is expected to 120 million yuan, introduces new industrial robot, five axis machining center, machine Polishing equipment.

东正创立于1993年，注册资金5508万，是一家专注于研发高品质PID过程控制器、阀门定位器、流量控制器，阀门控制单元，高洁净过程控制阀、智能自控阀，高洁净泵、高洁净管材和管道配件。公司高度专业化的产品和技术专注于生物制药、食品饮料、酿酒、精细化工等工业领域。东正众多的创新解决方案，对满足全球，尤其是新兴市场不断增长生物制药和食品饮料行业的需求起到了积极作用。

东正制造的产品母材料、加工技术、焊接技术、表面处理等技术指标均已达到国内外先进水平。且符合ASME BPE、EHEDG、FDA、3A等一系列国际标准和规范要求，先后通过了由德国 TÜV机构实施的欧盟承压设备指令(PED-97/23/EC)和(MD-06/42/EC)认证、美国 3A机构实施的3-A卫生标准认证、中国安全阀特种制造设备(TS)许可证和中国质量认证中心CQC ISO9001:2008 质量管理体系认证等多项国际权威认证。

东正凭借先进的技术、优异的品质和完善的售后服务体系，先后被评定为国家高新技术企业，省著名商标、省科技型企业、创新型企业、专利示范企业、研发中心企业，守合同重信用AAA企业等众多荣誉。



# 关于东正 About DONJOY

Donjoy was built up in 1993, with registered capital RMB 55.08 millions. We focus on developing high quality PID process controller, the valve positioner, the flow controller, the valve control unit, high purity process control valve, intelligent self-control valve, high purity pump, high purity tubing fitting and pipeline accessories. Donjoy's products and technologies are widely used in biopharmaceutical, food, drink, wine fine chemicals and other industrial fields. Donjoy's innovation solutions meet the growing demand of the industry of biopharmaceutical, food and beverage from the whole world, especially the emerging market.

Raw material, processing technology, welding technology, surface treatment from Donjoy have achieved advanced levels of domestic and foreign market. Donjoy productions according to ASME BPE, EHEDG, FDA and 3A standard, get certificate of PED-97/23/EC and MD-06/42/EC issued by TUV, 3A issued by 3A organization, TS licence and ISO9001:2008.

Donjoy with advanced technology, excellent quality and perfect after-sales service system, has been assessed as the national high-tech enterprises, the Provincial Famous Trademark, the Provincial Science and Technology Enterprises, Innovative Enterprises, Patent Model Enterprises, R & D Center, AAA Credit Enterprises.



创立于2005年现代化工厂  
温州滨海经济开发区生产基地  
Wenzhou binhai economic development zone production base

**DONJOY high-purity valve, pump, control system, pipe and accessories, provide the most excellent solution for various business scopes.**



Biopharmaceutical



Dairy



Food

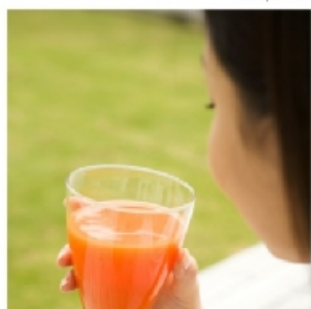

Beverage



Water Processing



Brewing



Fine Chemical

# 制造与检验 Manufacturing and testing



机器人生产线 Robot production line

全自动弯管设备 Automatic pipe bending equipment

DONJOY以科学技术是第一生产力，也是企业核心竞争力，只有不断投入核心技术研发和创新，不断追求卓越，精益求精、以先进生产设备，严格的质量管理体系，精密的生产检测流程，保证每一款产品优良的性能。

Science and technology constitute a primary productive force, also the core competitive strength of the enterprise. Continuously intensifying the research, development and innovation of core technology, pursuing prominence and keeping improving, ensuring the excellent quality and performance of every single product by advanced production equipment, strict quality control and precise production and inspection procedures.



# 荣誉与资质

## Honor and qualification

	<p><b>3A</b></p> <p>东正是美国3A认证组织的金牌赞助商，3A是一个自愿组织，致力于维护公共卫生和奶制品产品质量通过独特的行业监管程序的设备，用于处理乳制品的卫生标准3A认证。 东正通过认证产品，阀门系列55-02-1783、64-00-1784、84-02-1786、85-03-1787、53-06-1782、54-02-1580、68-00-1785，管件(63-03)证书号(1581)等多种规格型号。</p>
	<p><b>PED/97/23/EC &amp; MD/06/42EC</b></p> <p>东正通过了TUV 欧共体压力设备97/23/EC质量保证模式H&amp;材料(管件)制造认证。 阀门证书 NO.CE 0036 泵类证书 NO.705201402401-00</p>
	<p><b>FDA177.2600</b></p> <p>东正生产的阀门和泵以及流体设备等，与物料接触密封圈全部通过或符合美国食品和药品管理局和联邦法规第21条即，CRF 21 FDA177.2600和FDA177.1550认证，其涵盖： EPDM VITON(FPM) SILICON HNBPTFE橡胶塑料材料等。</p>
	<p><b>ISO9001/2008</b></p> <p>东正通过中国质量认证中心CQC，ISO9001-2008/GB/T19001-2008企业质量管理体系认证。其证书编号: 00108Q24215R1M/3302</p>
	<p><b>卫生许可证</b></p> <p>东正通过了省卫生厅卫生阀门、卫生管件等检验，且获得了其颁发的证书，其编号: So083。 其许可证为国家出台的生活饮用水卫生监督管理方法证书。</p>
	<p><b>高新技术企业</b></p> <p>东正通过多年发展和技术创新已获得了多项国家发明专利，100多项实用新型专利，现已成为国家高新技术企业。</p>
	<p><b>浙江省著名商标</b></p> <p>东正09年获得了温州市著名商标，2012年获得了浙江省著名商标。</p>

DONJOY不但拥有以上认证和荣誉，且被评定为省科技型、创新型、专利示范、研发中心、守合同守信用企业等众多的荣誉证书。



# 过滤器(直通、角式、Y型) Filter(straight, angle, Y type)

## 应用 Applications

在食品加工，化妆品和一些化学工业，还有制药工业的辅助服务中，过滤器有着广泛的应用。它的设计卫生，应用于过滤会对泵和其它设备造成损坏的颗粒。

Filters are widely used in the auxiliary service for food processing, cosmetic, chemicals and pharmacy industries. Due to its hygienic design, it is mainly used to filter the particulates that destroy pumps and some other equipments.

## 工作原理 Operating principles

该过滤器基本上由带进口和出口的过滤体组成，筛网装于过滤体的内部，筛网保留所有等于或大于网孔的颗粒。

The filter consists of inlet and outlet housing, inner screen mesh to filter the particulates and impurities which can't pass the mesh.

## 材质 Materials

过滤体: AISI 316L AISI304  
垫圈: EPDM FDA 177.2600  
内表面处理:  $Ra < 0.8 \mu m$   
外表面处理: 镜面抛光

Housing: AISI316L/AISI304  
Gasket: EPDM according to FDA 177.2600  
Inner polish:  $Ra < 0.8 \mu m$   
Outside polish: mirror polish



角式过滤器  
Angle type filter

直通过滤器  
Straight type filter





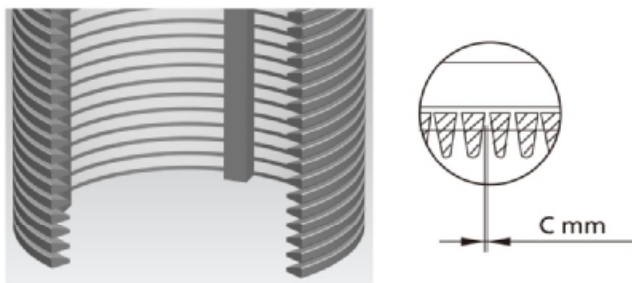

管道过滤器滤芯 Filter Element

### 选项 Options

垫圈: Silicon MVQ FPM  
 连接: 卡箍、螺纹、焊接  
 标准: DIN,SMS,RJT,IDF,3A  
 网孔: 0.5mm到2.0mm  
 筛网: 30目到300目

Gaskets:silicon MVQ FPM  
 Connections:clamp,Thread,weld  
 Standard:DIN,SMS,RJT,IDF,3A  
 Mesh Size:0.5mm to 2.0mm  
 Screen:30mesh to 300mesh

### 拆卸 Disassembly

拆卸时请务必保证管道里面没有任何的液体或物料, 否则会导致人身伤害。用合适的扳手或夹钳工具拧开卡箍螺母; 取出卡箍; 用手抬起环形手柄连同滤芯取出; 这样就可以清洗、更换。

Note: For security,Pls make sure there is no media in pipeline  
 Screw the nut by wrench or jaw,and then take off the clamp,and withdraw the handle together with the filter element.Finally,you can do the cleaning and replacment safely.

### 技术规范 Technical Specifications

规格: DN25-DN150 1"-6"

工作温度: -10°C到+120°C(EPDM)14oF到248oF+140°C  
 (SIP,30分)284oF

最大工作压力: 10bar 145PSI

Sizes: DN25-DN150 1"-6"

Working temperature: -10°C to+120°C(EPDM) 14oF to 248oF  
 +140°C ( SIP,max.30min) 284oF

Max.working pressure: 10bar 145PSI

### 扁型开口滤网 Wedge screen

目数 EQ.MESH	间距 C(en mm)	有效面积 Useful Surface
40	0.40	28%
60	0.30	23%
80	0.20	17%
165	0.10	10%
325	0.05	5%

筛网 Metal mesh



多孔板 Perforated plate

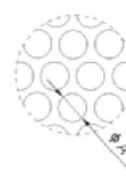

### 筛网: 金属网 Metal Mesh

网孔目数 Mesh	B (mm)	有效面积 Useful Surface(%)
30	0.55	48
40	0.40	46
60	0.30	52.6
80	0.20	42
100	0.15	36.2
165	0.10	45.4

### 筛网: 多孔板 Perforated Plate

A (mm)	有效面积 Useful Surface(%)
0.5	15
1	28
1.5	33
2	30
3	33
5	46

# 过滤器(直通、角式、Y型) Filter(straight, angle, Y type)



## 概述 Summarize

过滤器是除去液体中少量固体颗粒的小型设备,可保护压缩机、泵、仪表和其它设备的正常工作,当流体进入置有一定规格滤网的滤筒后其杂质被阻挡,而清洁的滤液则由过滤器出口排出,当需要清洗时,只要将可拆卸的滤筒取出,处理后重新装入即可,因此,使用维护极为方便。

该系列过滤器具有结构紧凑、过滤能力大、压损小、适用范围广、维护方便、价格低廉等优点其主要适用的物料有食品、制药生产中有卫生要求的物料,如:啤酒、饮料、乳制品、糖浆等。

Filter is used to eliminate the small particulates from compressors, pumps, meters and some other equipment. When liquids flow through the screen, impurity can be held up. And then pure liquids come out through the outlet. When cleaning is needed, you just draw out the cartridge. And put it back after cleaning, it is a very convenient process. Such series filters are compact designs. Strong filter power. Small damage. Favorable price, they are mainly used in food, beverage, dairy and pharmacy industries.

角式过滤器,无需拆卸管道,  
松开过滤器的螺母或卡箍即可取下滤网。如图所示

Angle type filter: No need to disassemble pipeline, just loose the nut or clamp, then the mesh can be took off easily as shown on right figure.



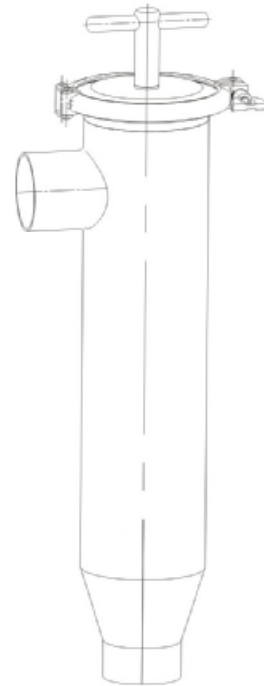

中头卡箍式过滤器

角式过滤器外形尺寸 Dimension of Angle type Filter

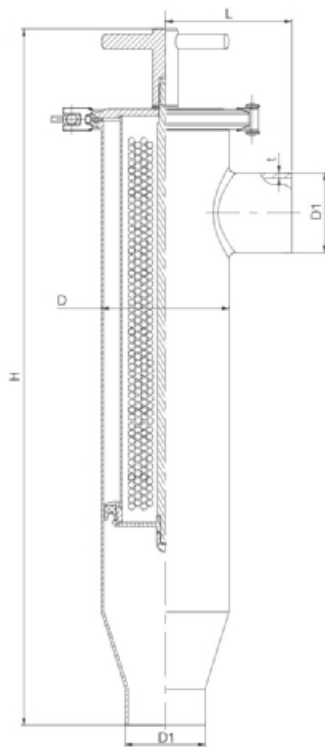

NO.EGL210

DIN角式过滤器 DIN Angel Type Filter

SIZE	H	L	D1		D	t
			1	2		
DN25	431	77.5	28	29	85	1.5
DN32	431	77.5	34	35	85	1.5
DN40	431	77.5	40	41	85	1.5
DN50	431	77.5	52	53	85	1.5
DN65	561	101	70	-	102	2.0
DN80	580	107	85	-	114	2.0
DN100	724	105.5	100	-	154	2.0

INCH角式过滤器 INCH Angel Type Filter

SIZE	H	L	D1	D
1"	431	77.5	25.4	85
1 1/4"	431	77.5	31.8	85
1 1/2"	431	77.5	38	85
2"	431	77.5	50.8	85
2 1/2"	561	101	63.5	102
3"	580	107	76.2	114
3 1/2"	580	107	89	114
4"	724	105.5	101.6	154

# 过滤器(直通、角式、Y型) Filter(straight, angle, Y type)

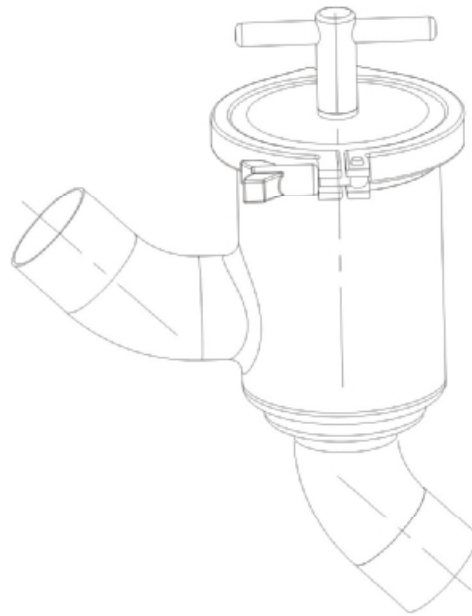

Y型过滤器外形尺寸 Dimension of Y type Filter

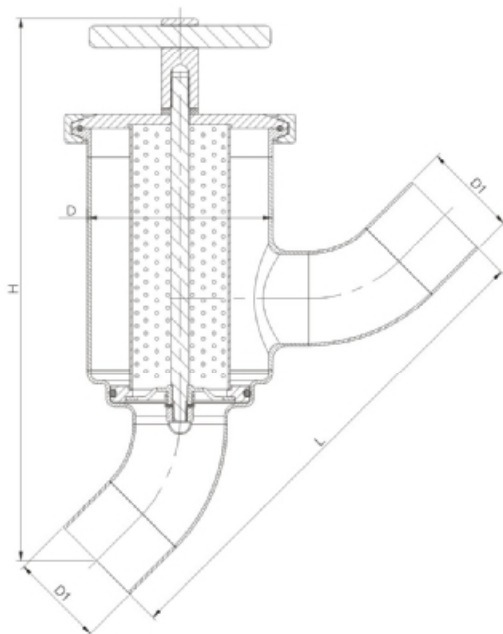

NO.EGL310

DIN Y型过滤器 DIN Y Type Filter

SIZE	H	L	D1		D	t
			1	2		
DN25	282	204	28	29	102	1.5
DN32	292	226	34	35	102	1.5
DN40	293	242	40	41	102	1.5
DN50	313	280	52	53	102	1.5
DN65	384	362	70	-	114	2.0
DN80	401	406	85	-	114	2.0
DN100	544	460	104	-	154	2.0

INCH Y型过滤器 INCH Y Type Filter

SIZE	H	L	D1	D
1"	280	204	25.4	102
1 1/4"	290	226	31.8	102
1 1/2"	298	242	38	102
2"	315	280	50.8	102
2 1/2"	387	362	63.5	114
3"	407	406	76.2	114
3 1/2"	410	406	89	114
4"	554	460	101.6	154

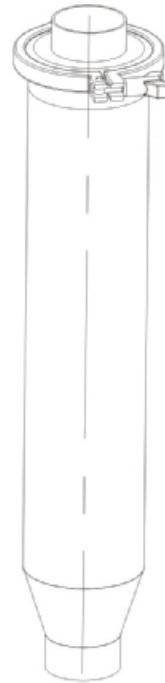

直通过滤器外形尺寸 Dimension of Straight type Filter

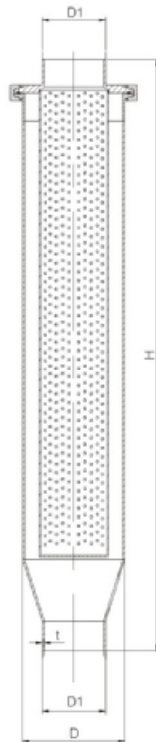

NO.EGL110

DIN直通过滤器 DIN Straight Type Filter

SIZE	H	D1		D	t
		1	2		
DN25	406.5	28	29	85	1.5
DN32	406.5	34	35	85	1.5
DN40	406.5	40	41	85	1.5
DN50	406.5	52	53	85	1.5
DN65	485	70	-	102	2.0
DN80	534	85	-	114	2.0
DN100	642	104	-	154	2.0

INCH直通过滤器 INCH Straight Type Filter

SIZE	H	D1	D
1"	406.5	25.4	85
1 1/4"	406.5	31.8	85
1 1/2"	406.5	38	85
2"	406.5	50.8	85
2 1/2"	485	63.5	102
3"	534	76.2	114
3 1/2"	534	89	114
4"	642	101.6	154

# 双联过滤器 Duplex filter



## 应用Applications

该双联过滤器适用于去除鲜奶、糖液、饮料等液体中各桶内肉眼无法看见的固体物的净化。两只过滤器交替使用，可不停机更换或洗滤网，适用于长期连续生产。

This duplex filters is applied to eliminate the invisible solids from dairy, beverage and pulps, so as to purify the liquids. The two filters can run alternatively and continually. Because they can be replaced or cleaned without powering off.

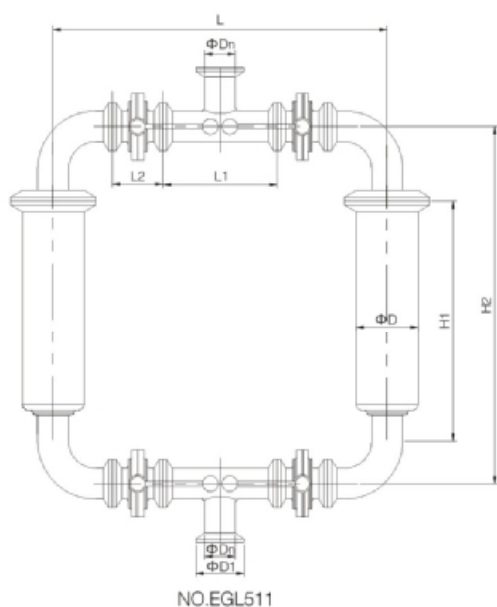

双联过滤器(直通型) Duplex filter(Straight type)

SIZE	Dn	D	D1	L	L1	L2	H1	H2
2"	51	85	64	532	200	76	360	557

## 技术规格Technical specifications

过滤体: AISI 316L、AISI 304  
 垫圈: EPDM FDA 177.2600  
 内表面处理:  $Ra < 0.8 \mu m$   
 外表面处理: 镜面抛光  
 网孔: 0.5mm to 2.0mm  
 筛网: 30目 to 300目  
 尺寸: DN 25–DN150/1"–6"  
 工作温度:  $-10^{\circ}C$ 到 $120^{\circ}C$ (EPDM)14OF到248OF  
 $+140^{\circ}C$ (SIP, 30分)284OF  
 最大工作压力: 10bar 145PSI

Cartridge:AISI 316L/AISI 304  
 Gasket:EPDM according to FDA 177.2600  
 Inner polish: $Ra < 0.8 \mu m$   
 External polish:mirror polish  
 Screen hole:0.5mm–2.0mm  
 Screen:30–300 meshes  
 Size:DN 25–DN150/1"–6"  
 Working temperature: $-10^{\circ}C$  to  $120^{\circ}C$  (EPDM)14OF to248OF  
 $+140^{\circ}C$ (SIP,max.30 min)284OF  
 Max.working pressure:10bar 145PSI

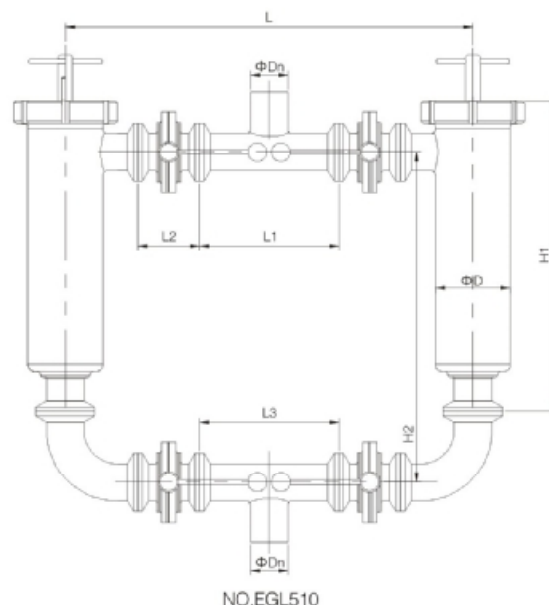

双联过滤器 Duplex filter(Angle type)

SIZE	Dn	D	L	L1	L2	L3	H1	H2
1.5"	38	85	510	190	70	190	369	362
2"	51	85	532	200	76	200	369	362
2.5"	63.5	102	605	218	80	218	505	529
3"	76	114	632	210	84	210	523	522
4"	101.6	154	799	337	104	254	650	693

# 微孔过滤器

## Micro-filter

### 运用原理 Operating principles

微孔过滤器它可以滤除液体、气体的 $0.1\mu\text{m}$ 以上的微粒和细菌，它有过滤精度高、过滤速度快、吸附少、无介质脱落、耐酸碱腐蚀、操作方便等特点。现已广泛用于医药、化工、电子、饮料、果酒、生化处理、环保等工业的必须设备。

其特点是体积小、重量轻、使用方便、过滤面积大、堵塞率低、过滤速度快、无污染、热稀稳定性及化学稳定性好。

用户在使用前，必须根据过滤用途、介质情况、配置不同形式、不同材质的滤芯。如GMP厂制药用水，可以和 $5\mu\text{m}$ 和 $1.0\mu\text{m}$ 褶皱膜筒式滤芯两组串接使用。在发酵工业中空气过滤，可以对送入空气进行除菌，除噬菌体过滤，也可封排出尾气进行处理，达到美国细菌过滤HIM标准。

Micro-filter can eliminate the particulates and bacteria larger than  $0.1\mu\text{m}$  from liquid and gas. It has the following advantages: high precision, fast speed. Low adsorption, no media fall off, acid resistant, lye-resistant. Easy operation. It is widely used in pharmacy, chemical, winery, beverage industries. Etc.

Futures: small volume, light weigh, large filter area, low jam, fast filter speed. Non-pollution, good chemical and calorific stabilities. Users should configure different material and type of filter for different purpose and medium. For example, for GMP pharmacy water, we use  $5\mu\text{m}$  and  $0.1\mu\text{m}$  folded sleeve filters tandem. Another one. In ferment industry, before inputting air, this filter can annihilate the bacteria; in addition, it can dispose the exhaust till the gas reaches HIM standard.

### 应用 Applications

在食品加工，化妆品和一些化学工业，还有制药工业的辅助服务中，过滤器有着广泛的应用。

Filters are widely used in the auxiliary service for food processing, cosmetic, chemicals and pharmacy industries.

### 技术规格 Technical Specifications

过滤量T/H:  $0.5\text{t/h} \sim 25\text{t/h}$

滤器使用压力mpa:  $0.1 \sim 0.6$

滤筒: 1芯、3芯、5芯、7芯

滤桶高度:  $10^\circ$ 、 $20^\circ$ 、 $30^\circ$ 、 $40^\circ$

滤芯材质: 聚四氟乙烯(PTFE)、聚砜(PE)、尼龙(Nylon)、聚丙烯(PP)等

过滤孔径有:  $0.1\mu\text{m}$ 、 $0.22\mu\text{m}$ 、 $1\mu\text{m}$ 、 $3\mu\text{m}$ 、 $5\mu\text{m}$ 、 $10\mu\text{m}$

分疏水性(适用于气体)和亲水性(适用于液体)

滤芯，可根据需要选用。

内表面处理: 粗糙度 $R_a < 0.2\mu\text{m}$ 。

滤桶材质: ASTM304/316L

Capacity:  $0.5\text{t/h} \sim 25\text{t/h}$

Pressure:  $0.1 \sim 0.6\text{mpa}$

Filter Seat: 1 core, 3 cores, 5 cores, 7 core

Length:  $10^\circ$ ,  $20^\circ$ ,  $30^\circ$ ,  $40^\circ$

Cartridge: PTFE/PE/NYLON/PP

Hole dia:  $0.1\mu\text{m}$ ,  $0.22\mu\text{m}$ ,  $1\mu\text{m}$ ,  $3\mu\text{m}$ ,  $5\mu\text{m}$ ,  $10\mu\text{m}$

Water alien filter(for gas) Water intimate filter(for liquid)

Internal Surface polish:  $R_a < 0.2\mu\text{m}$

Cartridge Material: ASTM304/316L



### 技术规格 Technical Specifications

根据过滤用途、介质情况、配置不同形式、不同材质的滤芯。如GMP厂制药用水，可以和 $5\mu\text{m}$ 和 $1.0\mu\text{m}$ 褶皱膜筒式滤芯两组串接使用。在发酵工业中空气过滤，可以对送入空气进行除菌，除噬菌体过滤，也可封排出尾气进行处理，达到美国细菌过滤HIM标准。

滤芯材质: 聚丙烯膜(PP)滤芯，聚四氟乙烯膜(PTFE)滤芯，醋酸纤维膜(CN-CA)滤芯。

滤芯精度:  $0.1 \sim 60\mu\text{m}$

长度有 $10$ 、 $20$ 、 $30$ 和 $40$ 英寸(即 $250$ 、 $500$ 、 $750$ 、 $1000\text{mm}$ )

滤芯耐压:  $0.42\text{Mpa}$ 。可反冲。

接口方式有插入式( $222$ 、 $226$ 座二种)和平嘴式二种。

Users should configure different material and type of filter for different purpose and medium. For example, for GMP pharrment industry, before inputting air, this filter can annihilate the bacteria; in addition, it can dispose the exhaust till the gas reaches HIM standard.

Materials for filter: PP/PTFE/CN-CA

Precision:  $0.1 \sim 60\mu\text{m}$

Length:  $10^\circ$ ,  $20^\circ$ ,  $30^\circ$ ,  $40^\circ$  ( $250$ ,  $500$ ,  $750$ ,  $1000\text{mm}$ )

Pressure resistance:  $0.42\text{Mpa}$ , Bounce-backed

Connections: plugged ( $222$ ,  $226$ ) / flat nib style

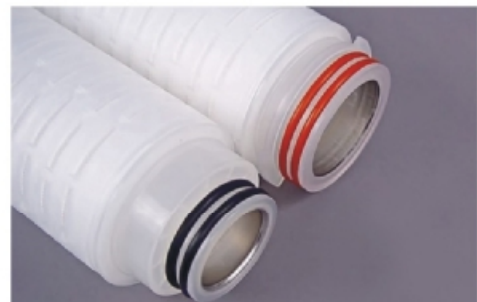

# 微孔过滤器 Micro-filter

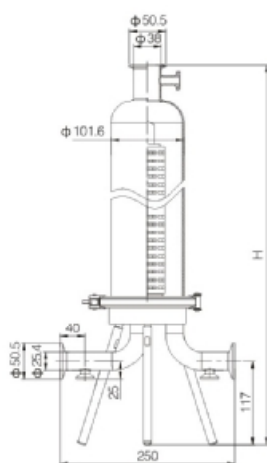

卡箱式  
Clamped micro-filter  
NO.EGL411-01

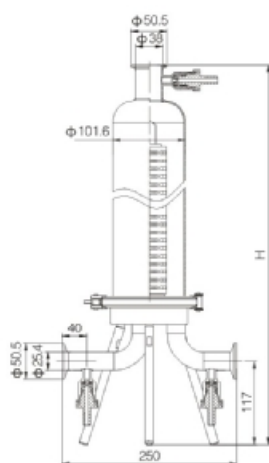

带取样阀式  
Micro-filter with sample valve  
NO.EGL421-01

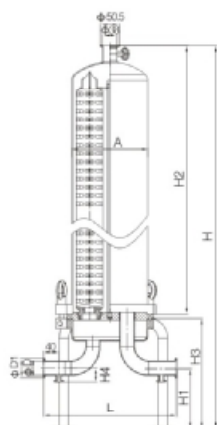

卡箱式  
Clamped micro-filter  
NO.EGL411-03/05/07

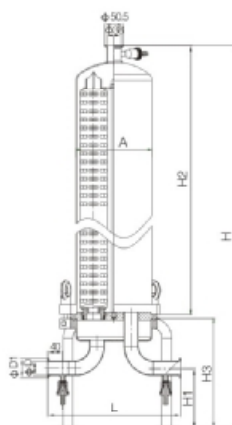

带取样阀式  
Micro-filter with sample valve  
NO.EGL421-03/05/07

## 单芯过滤器 Single core filter

Size	H	滤芯接口 Cartridge
5"	435	226(7#)
10"	560	226(7#)
20"	814	226(7#)
30"	1068	226(7#)

## 三芯过滤器 Three cores filter

Size	L	H	H1	H2	H3	H4	D	D1	A	滤芯接口 Cartridge
10"	350	685	160	380	293	35	38.1	50.5	204	226(222)
20"	350	935	160	630	293	35	38.1	50.5	204	226(222)
30"	350	1185	160	880	293	35	38.1	50.5	204	226(222)
40"	350	1435	160	1130	293	35	38.1	50.5	204	226(222)

## 五芯过滤器 Five cores filter

Size	L	H	H1	H2	H3	H4	D	D1	A	滤芯接口 Cartridge
10"	350	679	152	380	287	35	38.1	50.5	219	226(222)
20"	350	929	152	630	287	35	38.1	50.5	219	226(222)
30"	350	1179	152	880	287	35	38.1	50.5	219	226(222)
40"	350	1429	152	1130	287	35	38.1	50.5	219	226(222)

## 七芯过滤器 Seven cores filter

Size	L	H	H1	H2	H3	H4	D	D1	A	滤芯接口 Cartridge
10"	450	713	152	390	311	45	50.8	64	273	226(222)
20"	450	963	152	640	311	45	50.8	64	273	226(222)
30"	450	1213	152	890	311	45	50.8	64	273	226(222)
40"	450	1463	152	1140	311	45	50.8	64	273	226(222)



# 空气呼吸器 Rebreather

## 应用 Applications

- 利用微孔过滤器的过滤原理，防止储罐因液位下降吸入空气时外部空气中尘埃粒子的进入，保证了罐内空气的洁净度。
- 壳体材料采用进口316L或304
- 内表面经抛光处理
- 表面粗糙度Ra≤0.2 μm
- 流量: 0.75m<sup>3</sup>/min、1.5m<sup>3</sup>/min、3m<sup>3</sup>/min
- 接口方式: 卡箍式、法兰
- The principle is same as micro-filter's. It can prevent the outside particulates coming into the storage tank due to the liquid level descends. It ensures the air purity in the tank.
- Housing material: 316L/304
- Inner surface are polished
- Surface roughness: Ra≤0.2 μm
- Capacity: 0.75m<sup>3</sup>/min, 1.5m<sup>3</sup>/min, 3m<sup>3</sup>/min
- Connection: Clamped, Flanged



规格 SIZE	ID	OD
1"	22.4	50.5
1.25"	35.1	50.5
1.5"	35.1	50.5
2"	47.8	64

# 过滤器+冷凝水排放阀 Filter+condensation water

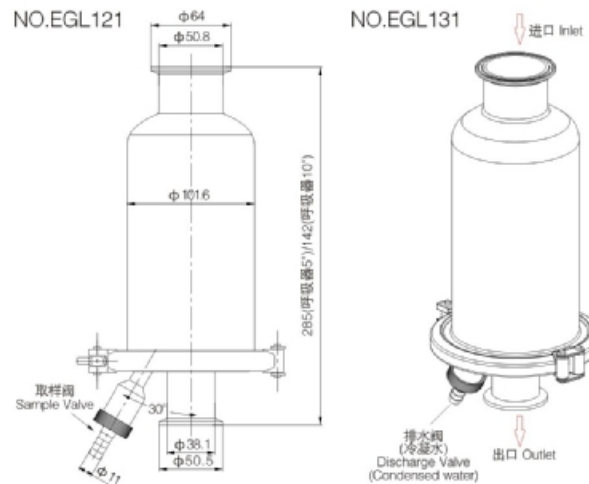

# 地漏 Floor drainer

## 应用 Applications

- 该地漏适用于食品、改料，制药等卫生洁净车间。  
全不锈钢制作，AISI304/316L  
规格从1"-4", DN25-DN100  
设计有网孔和污染头防止颗粒污料进入堵塞排泄管道  
可取下盖子和污料斗清洗地漏防止细菌繁殖
- The drainer is used in the hygienic workshops of food processing, pharmacy industries  
Material:AISI304/316L  
Size:1"-4",DN25-DN100  
Metal meshes and hopper can keep dirty particulates from blocking pipeline  
Cover and hopper can be cleaned to prevent bacteria from propagating



Size	A	D	D1
1"	80	25	130
1.5"	80	38	130
2"	100	51	195
2.5"	100	63	195
3"	130	76	230
4"	130	100	230



# CHINA DONJOY TECHNOLOGY CO.,LTD.

DONJOY looking forward to your visit! Your telecommunications!



中国·东正  
科技有限公司

地址: 温州龙湾区空港新区港富路25号  
总机: 0577-86990888  
传真: 0577-86998000

Add : No.25 Gang fu Road,  
kong gang new District,  
Longwan Wenzhou,China  
Tel: +86-577-86990888  
Fax: +86-577-86998000  
E-mail: donjoy@cndonjoy.com

[www.cndonjoy.com](http://www.cndonjoy.com)

法律声明:

目录样册版本属东正所有, 如有抄袭东正将追究其法律责任和经济赔偿。  
东正众多技术设计, 都具有专利保护, 如有抄袭, 东正必将追究法律责任和经济赔偿。